

Oak Micros Pinscape All in One

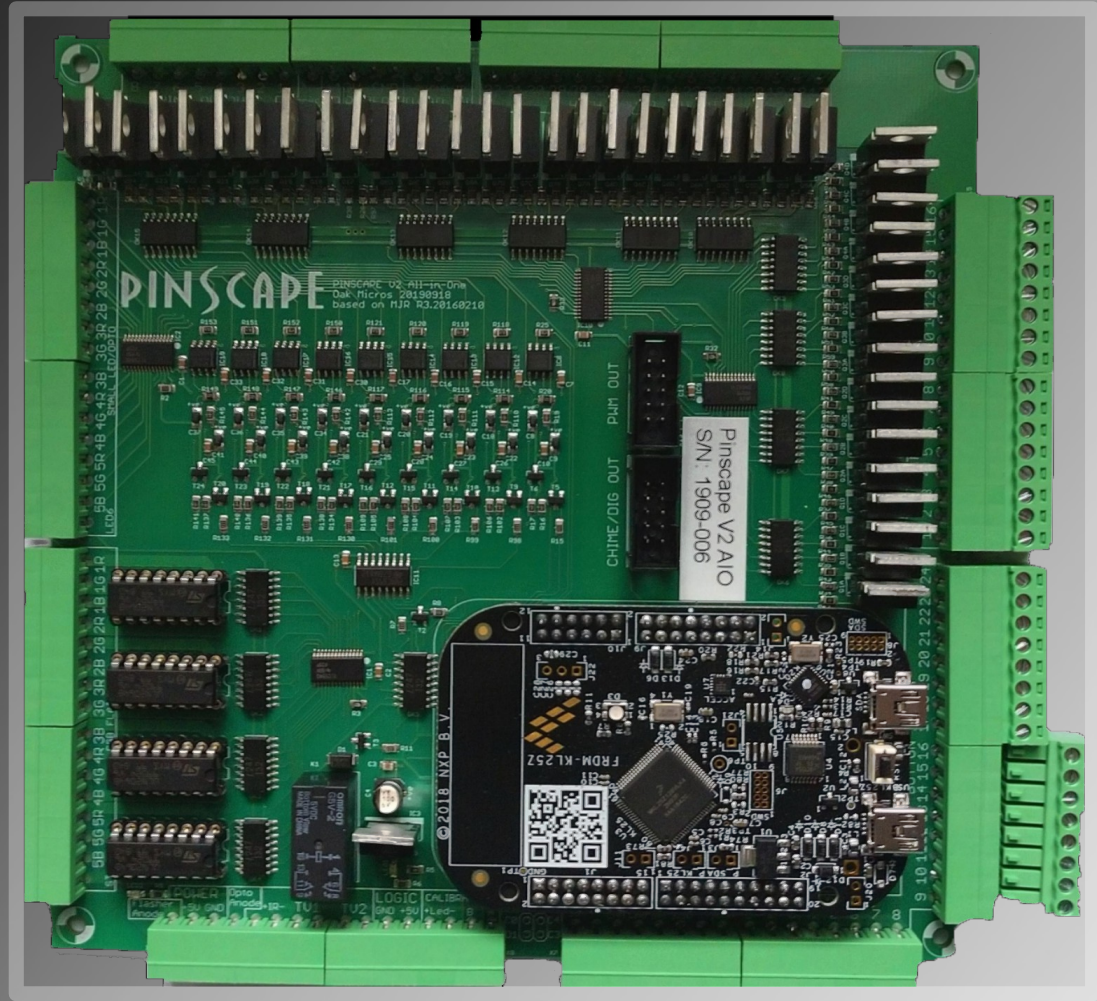

Connection Guide By Major Frenchy

(October 2020)



Oak Micros Pinscape All in One (Pinscape AIO)

The Pinscape AIO is a all in one solution for virtual pinball force feedback And LED management.

- 24 input buttons for everything from flipper buttons to a tilt bob
- Nudge support using an accelerometer
- TV remote control using IR
- 16 current limited LED outputs for 5V LED
- Nudge support using an accelerometer
- 16 power LED outputs (up to 1.5A)
- 32 MOSFET power outputs for driving higher powered devices
- 9 MOSFET power outputs
- Integrated KL25Z

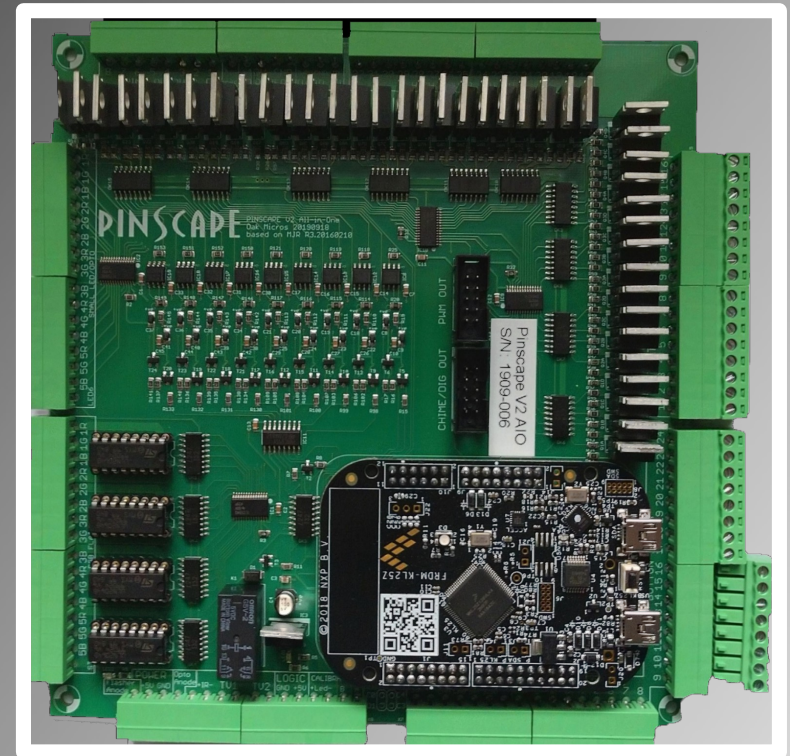

Oak Micros Pinscape All in One

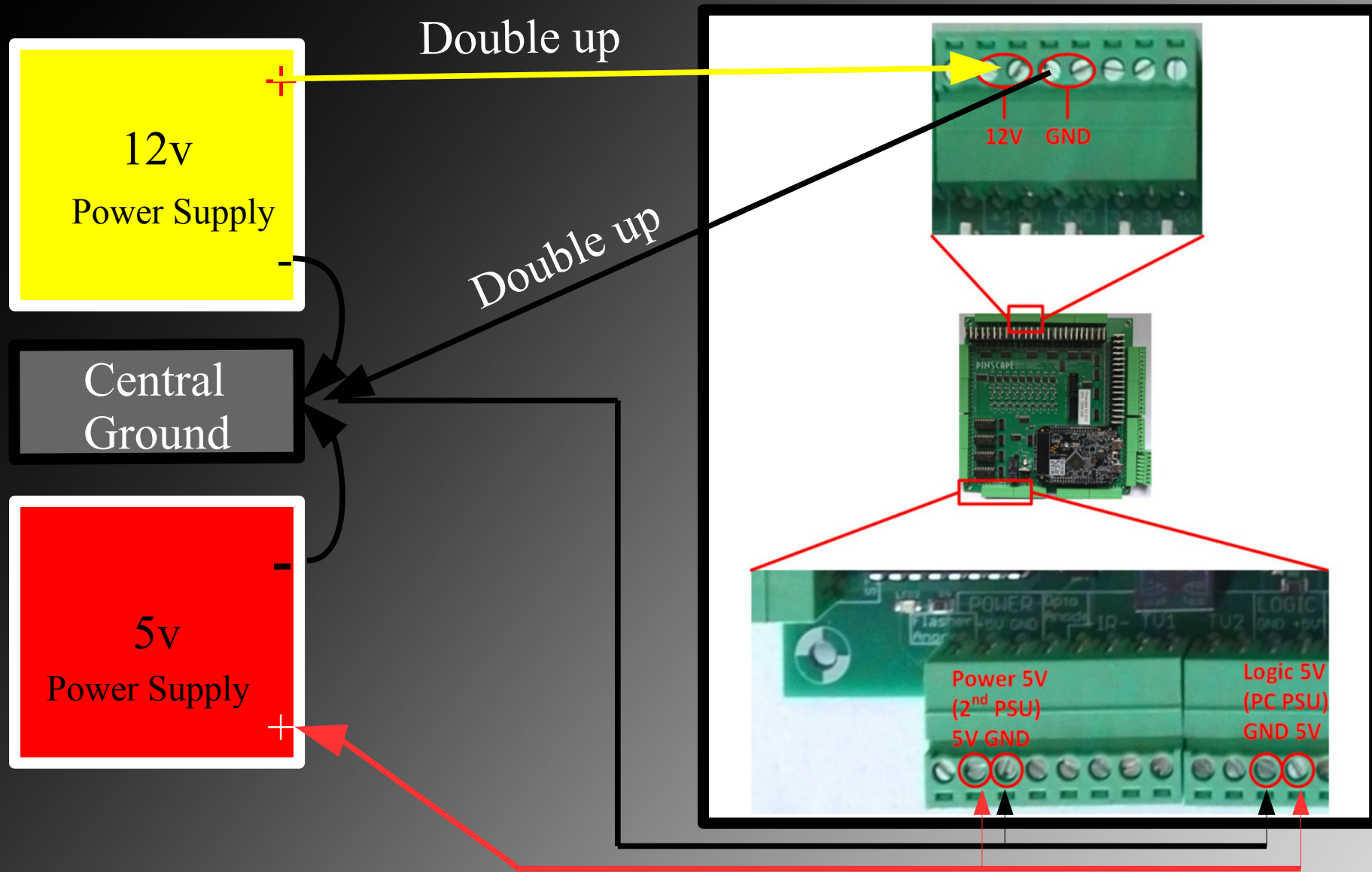

Powering up the Pinscape AIO



Oak Micros Pinscape All in One

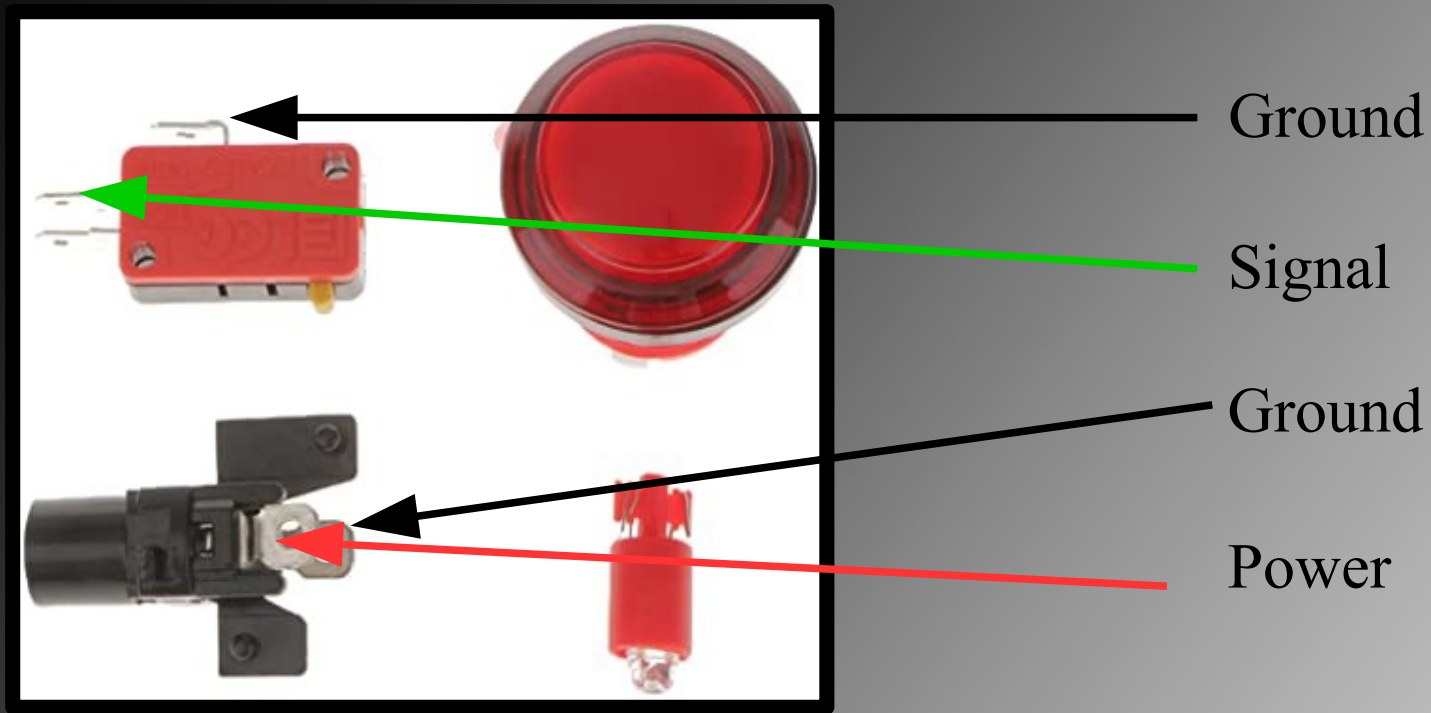

Connecting Buttons



Oak Micros Pinscape All in One

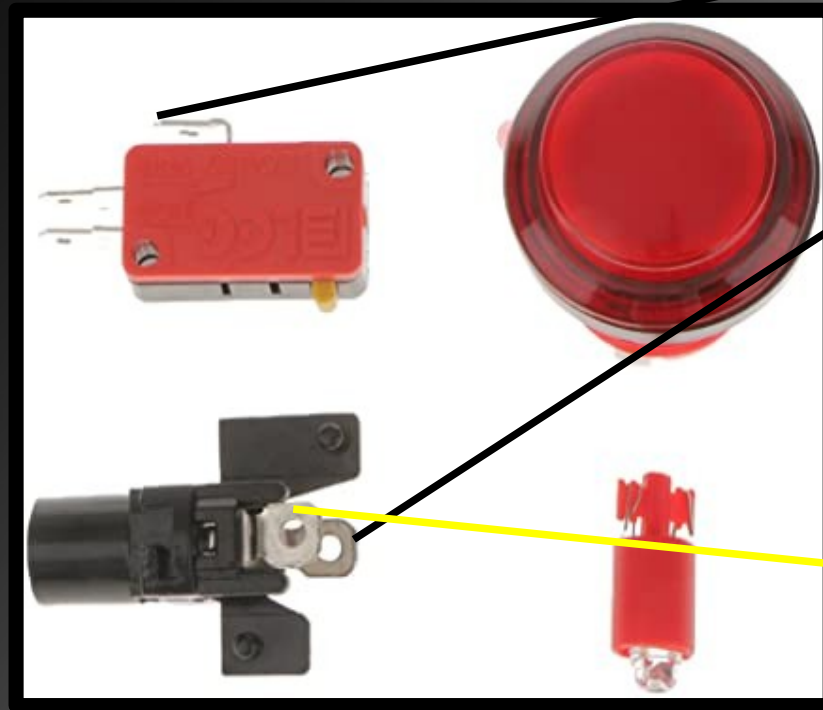

Connecting power to Button



Oak Micros Pinscape All in One

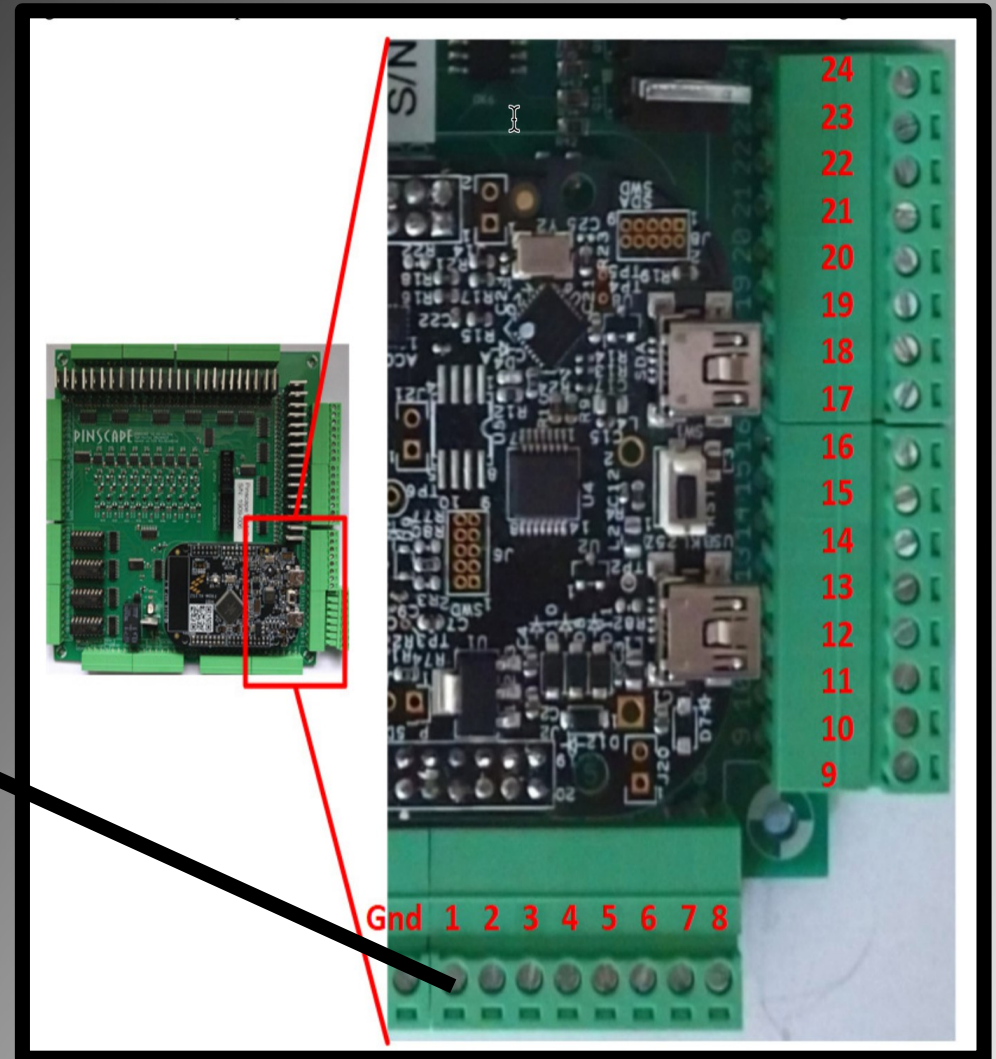

Connecting Button signal to Pinscape AIO



Oak Micros Pinscape All in One

If you want your Light to be activated in DOF

Connect the LED ground to a RGB LED port on the Pinscape AIO

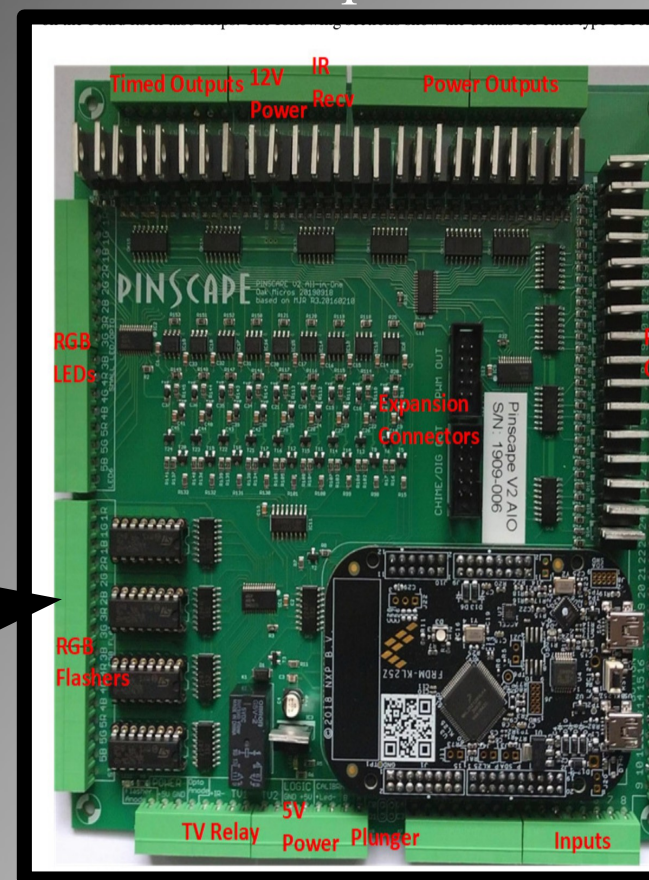

Connecting Buttons



Oak Micros Pinscape All in One

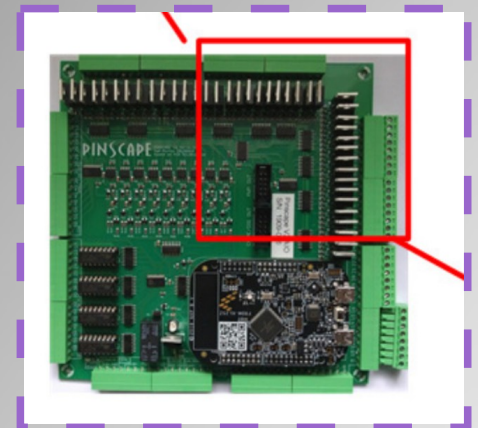
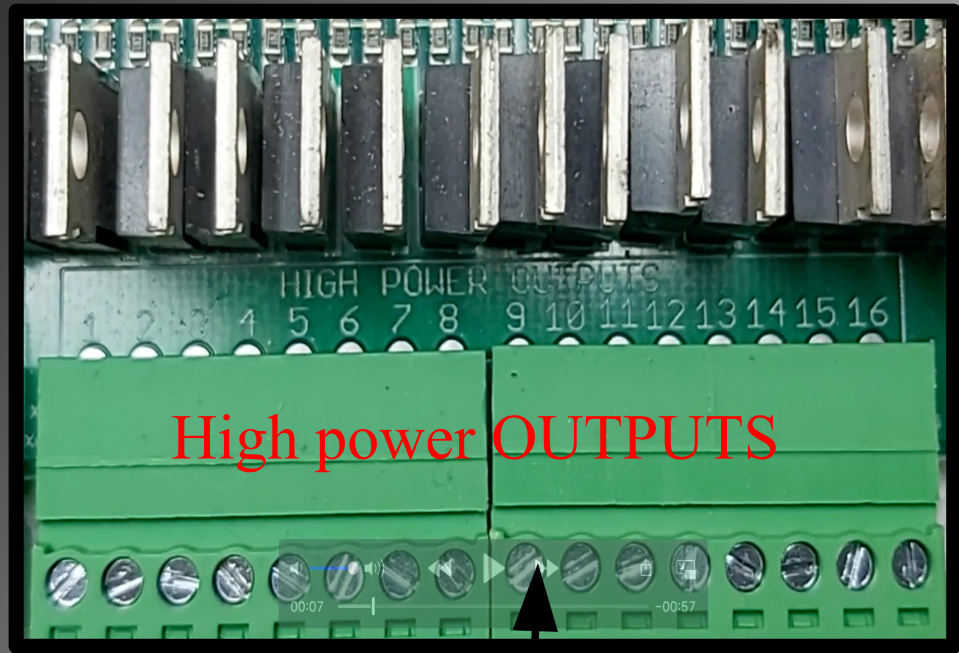
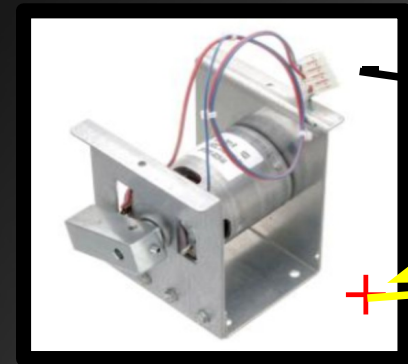
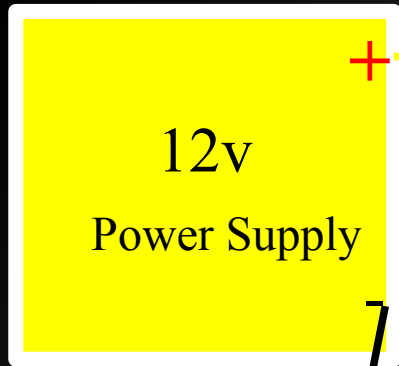

Diode value : 1N4004

Connecting Shaker Motor



Oak Micros Pinscape All in One

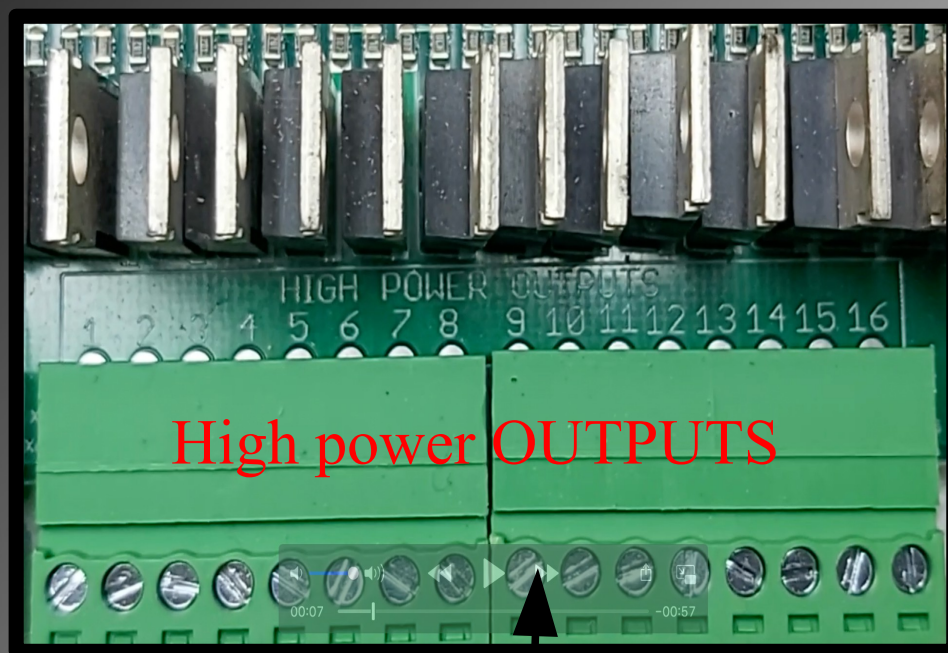

0.5A

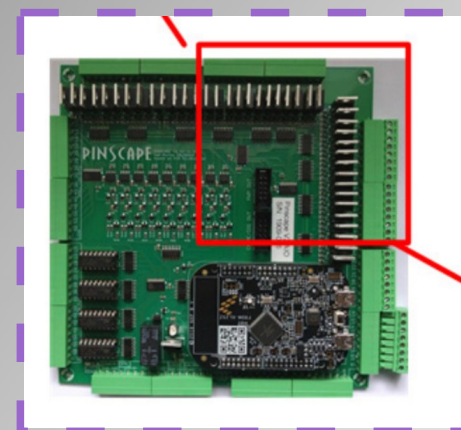
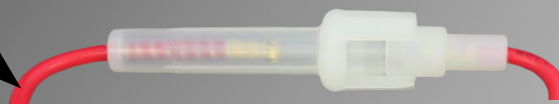

Diode value : 1N4004

Connecting Contactors



Oak Micros Pinscape All in One

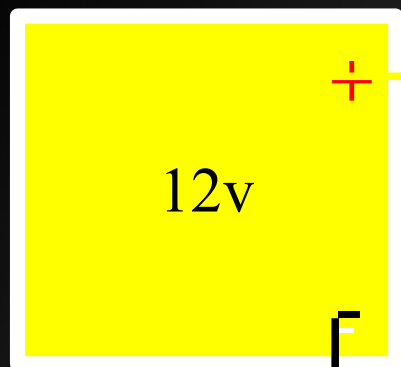

Central Ground

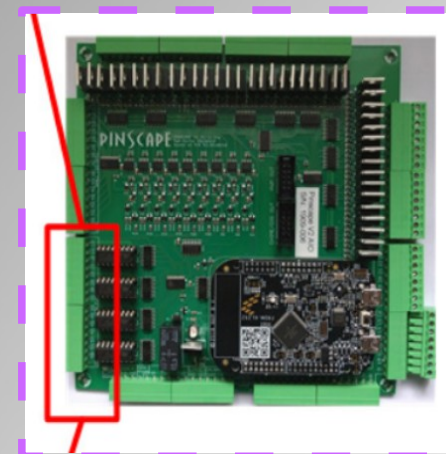
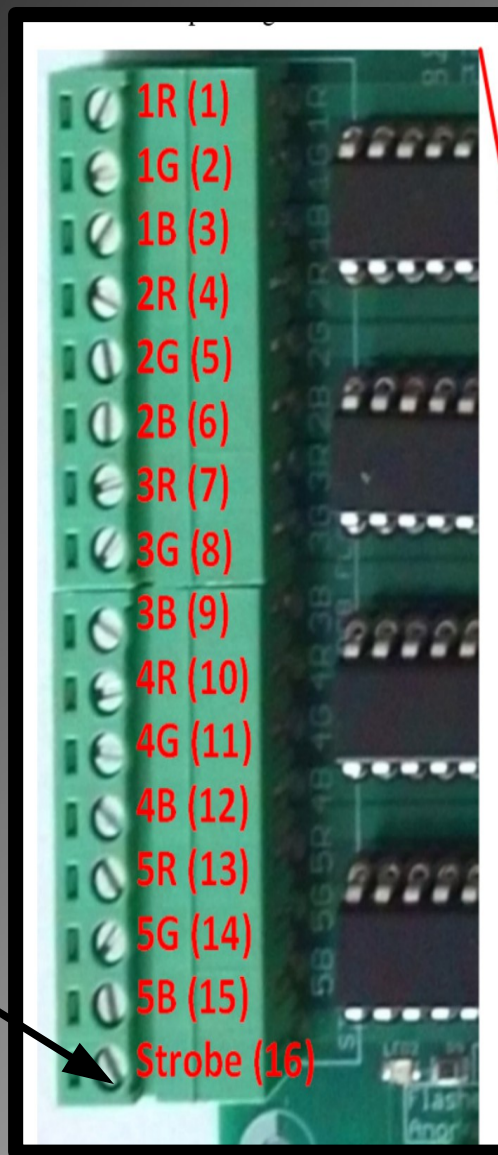
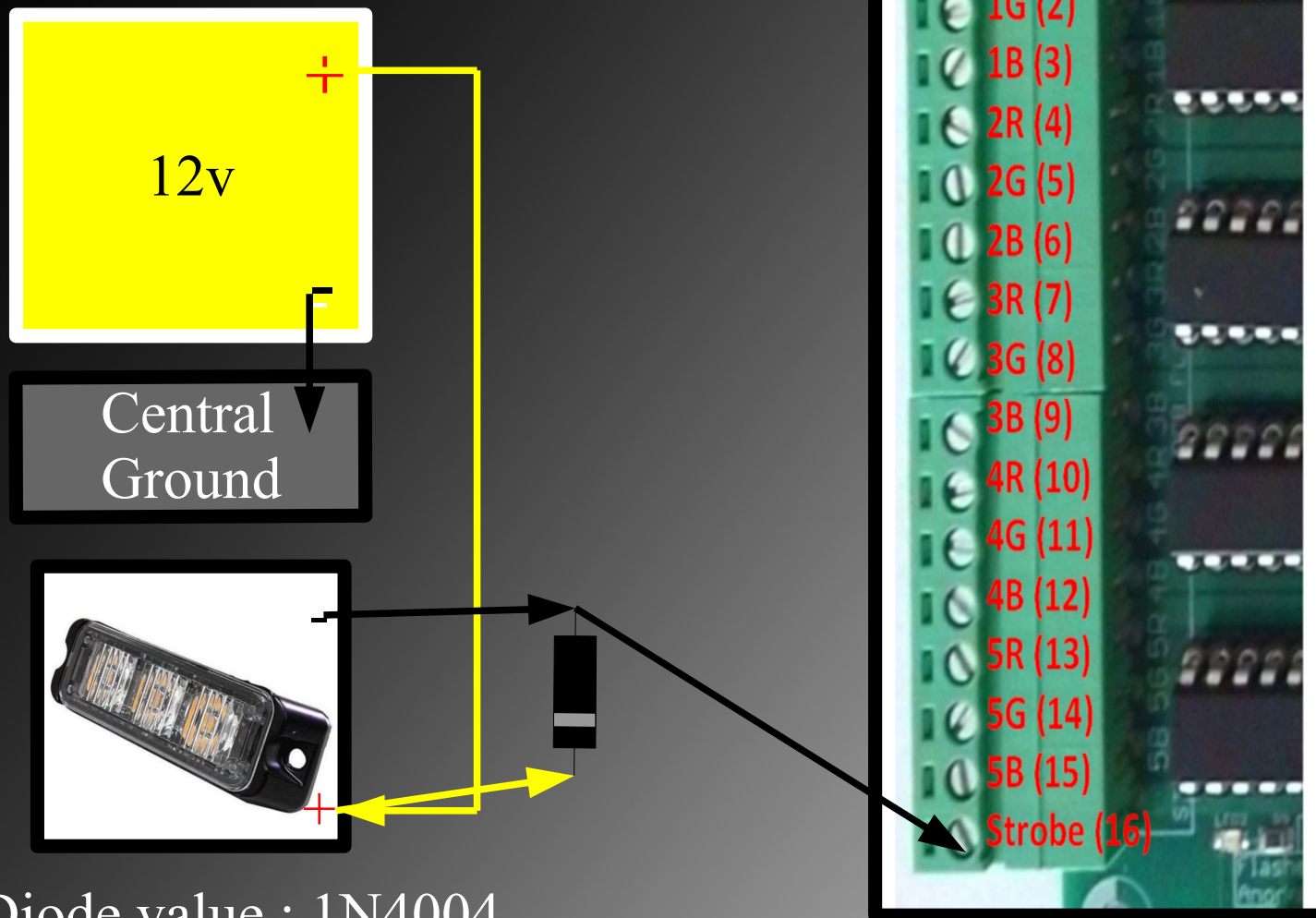

Diode value : 1N4004

Connecting Strobe



Oak Micros Pinscape All in One

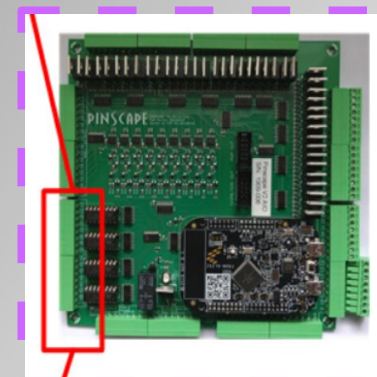
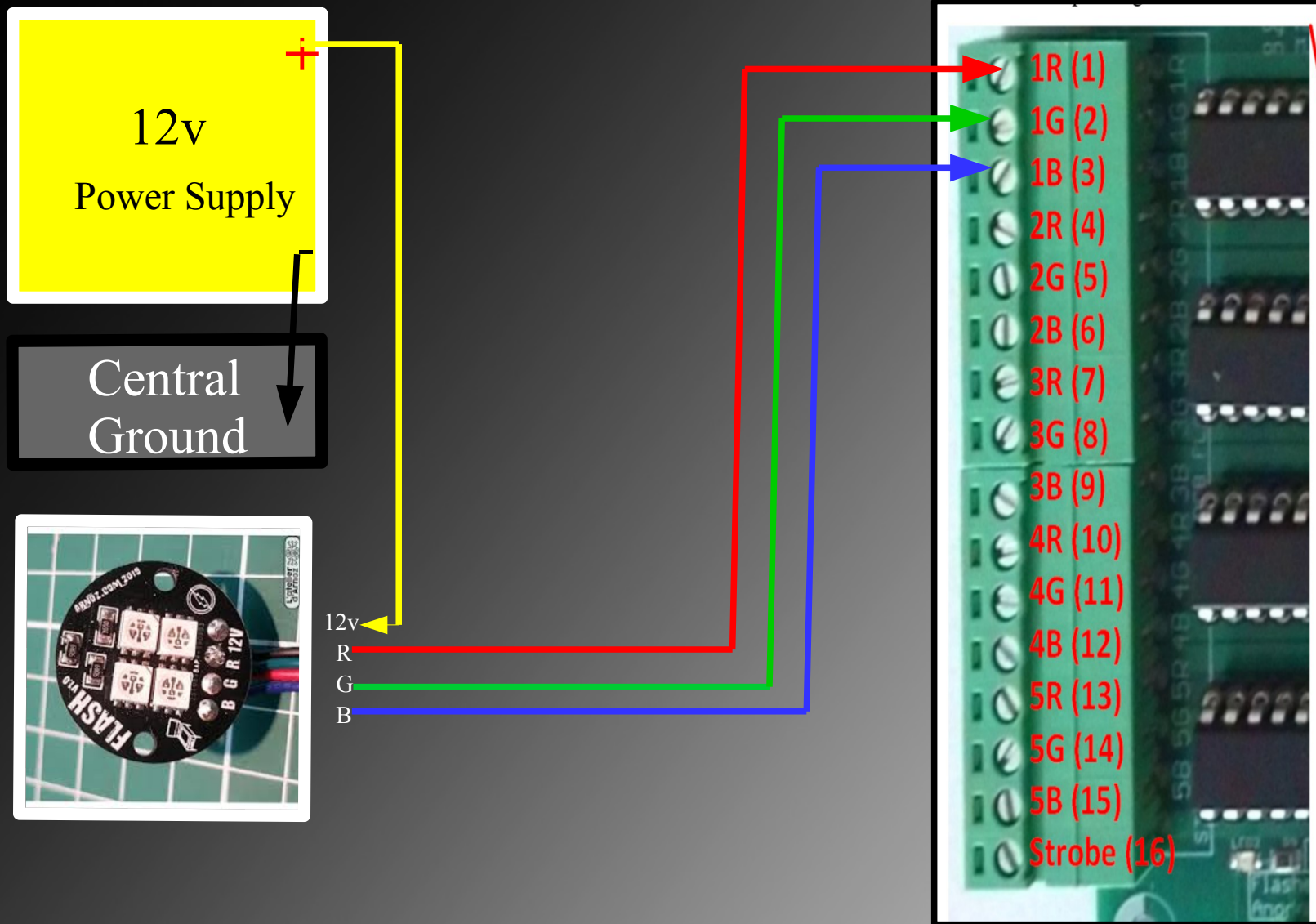

Connecting 5Led Flasher with built in resistors



Oak Micros Pinscape All in One

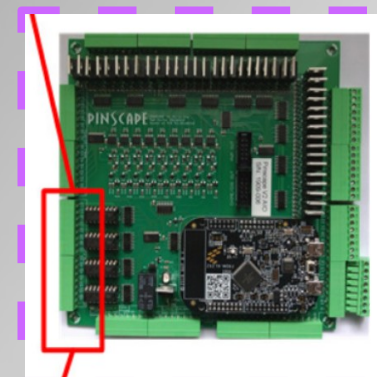
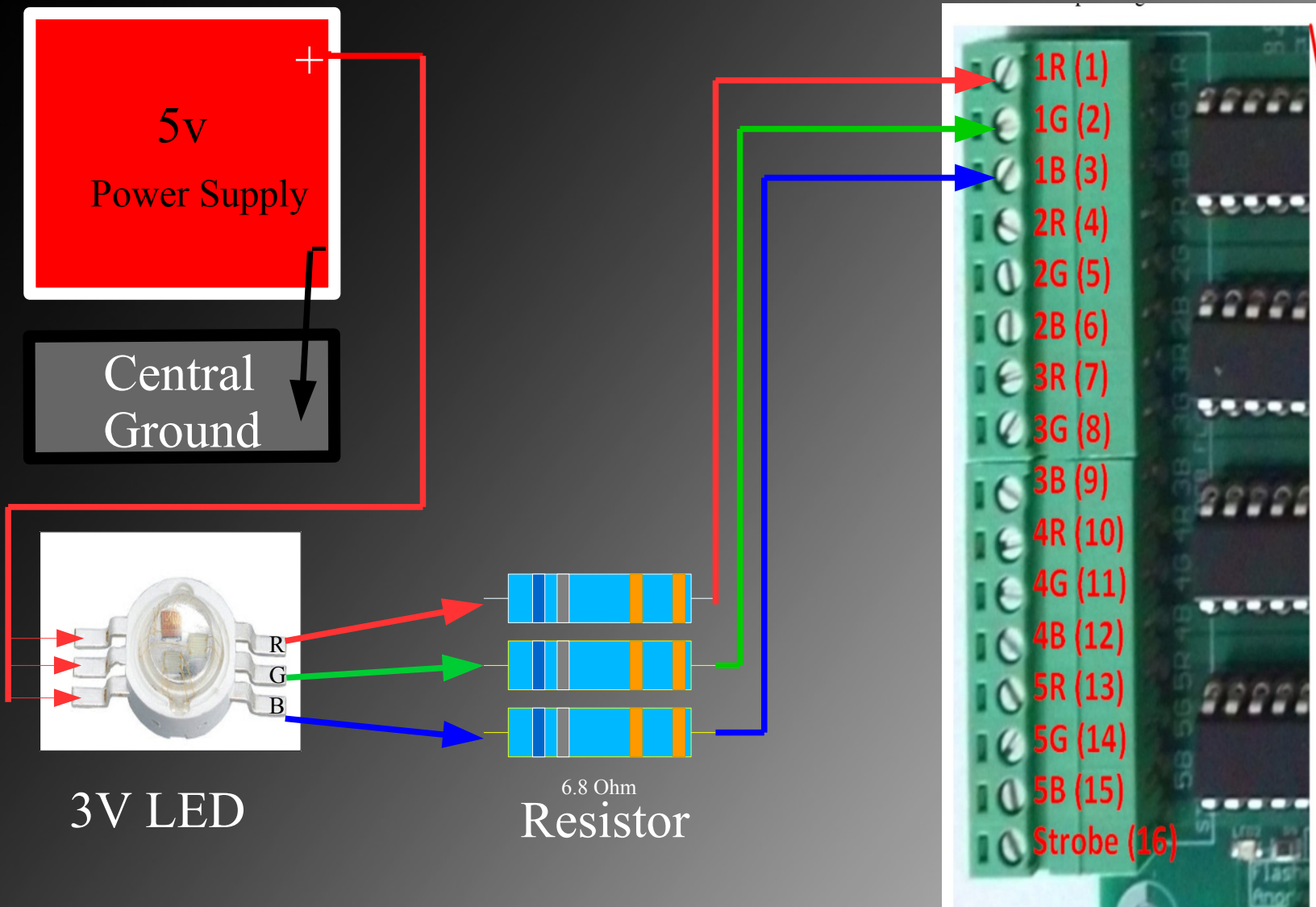

Connecting 5Led Flasher



Oak Micros Pinscape All in One

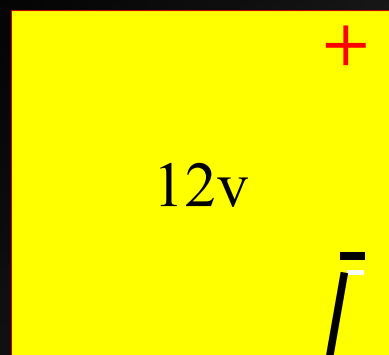

12v

Central Ground

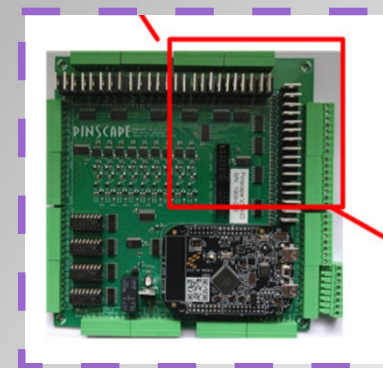
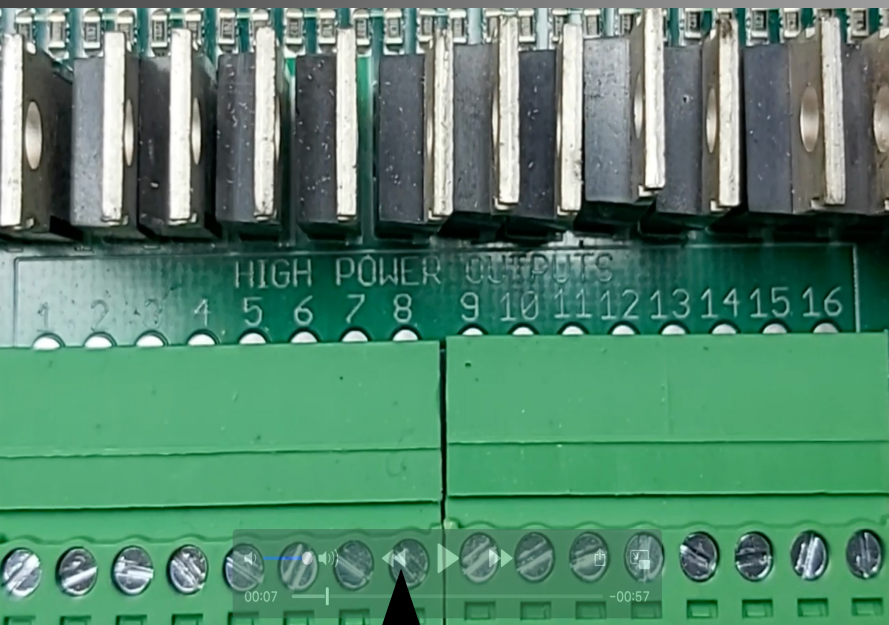

Diode value : 1N4004

Connecting Beacon



Oak Micros Pinscape All in One

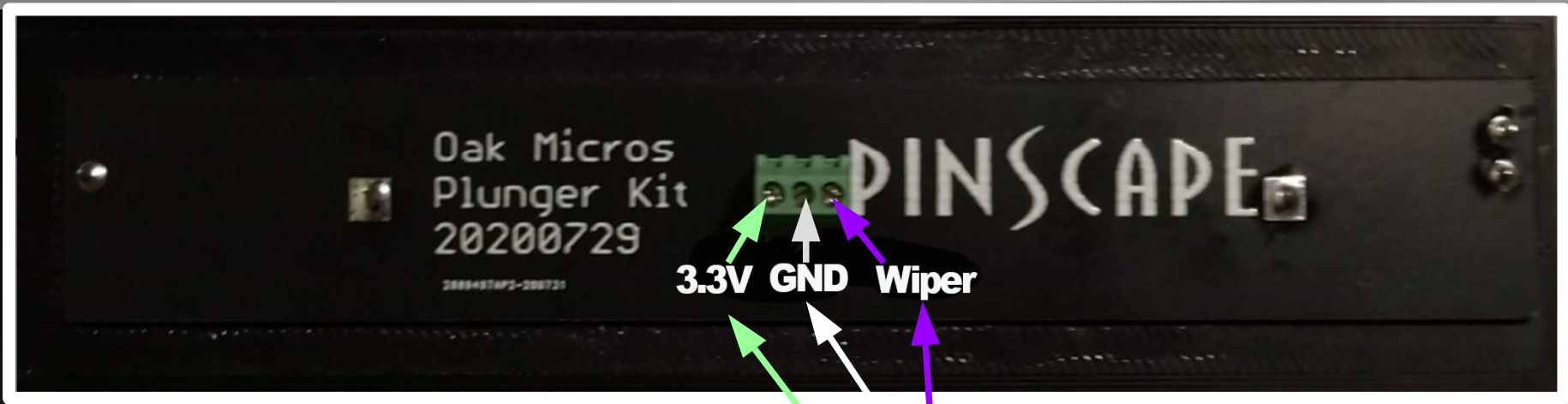

To computer USB

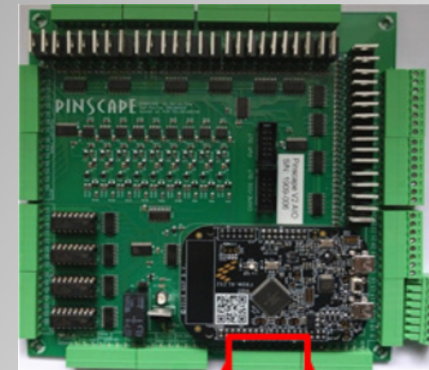
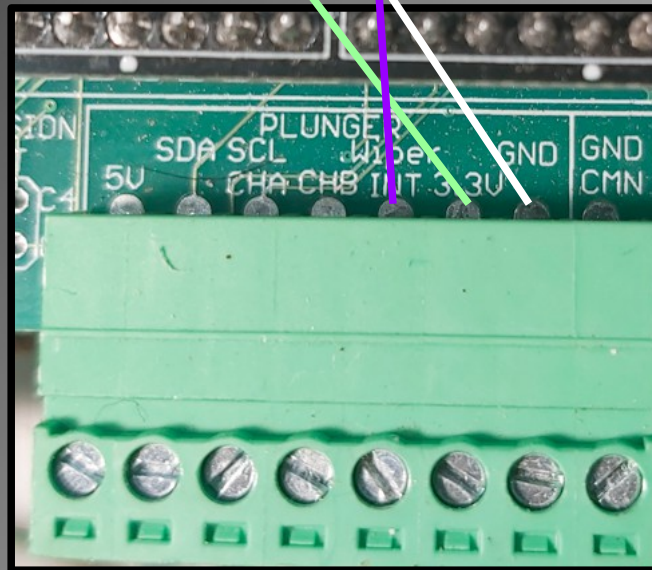
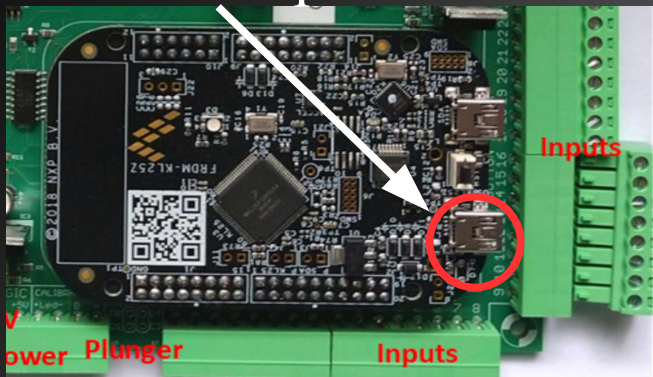

The Plunger gets the Power from the K125Z

Connecting Plunger



Oak Micros Pinscape All in One

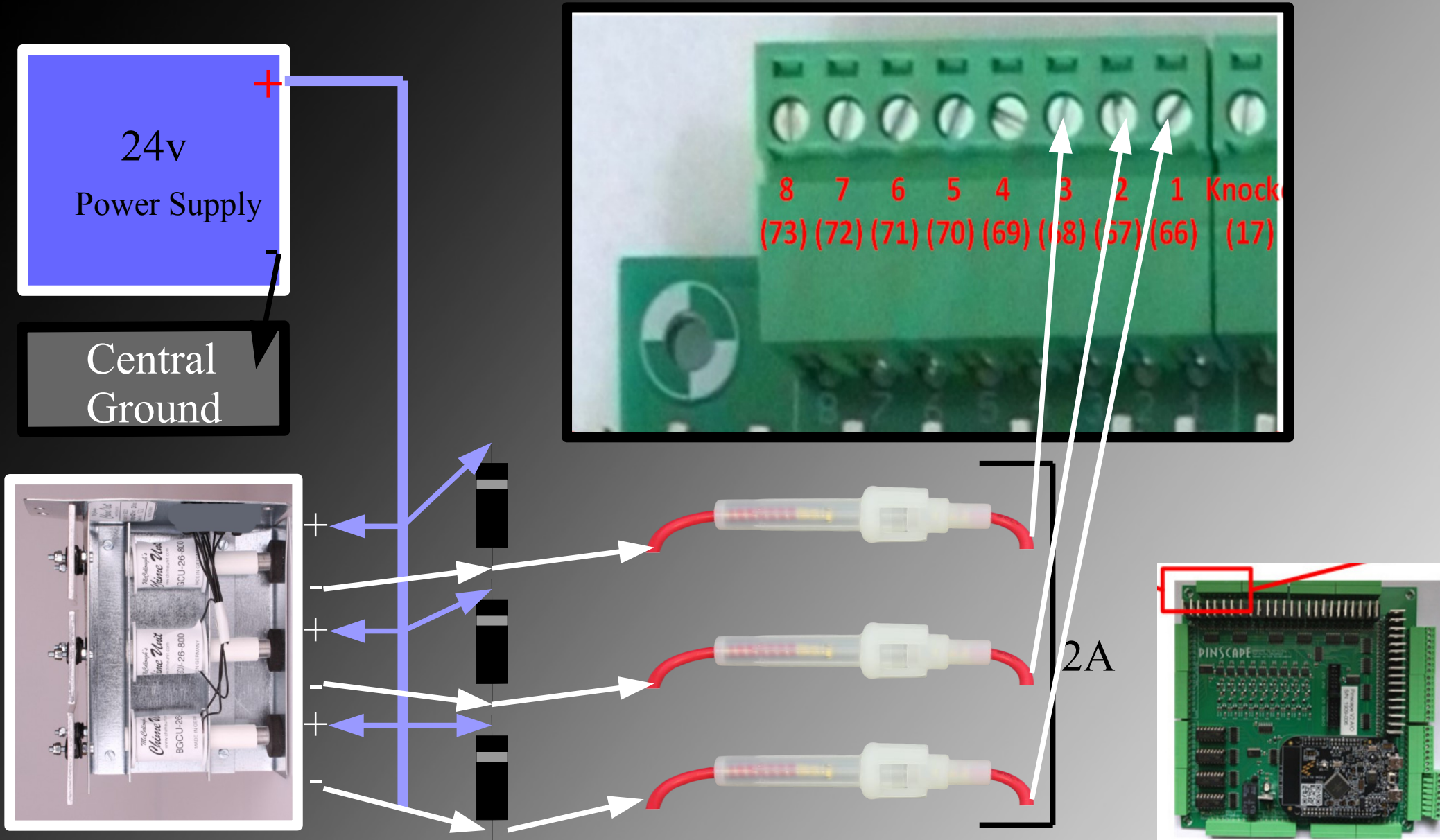

Connecting Chime (Diode value : 1N4004)

